

• MOTORENANBAU

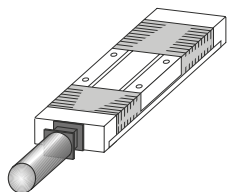

Spindelantrieb mit stirnseitigen Motoranbau

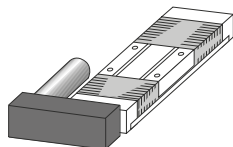

Spindelantrieb mit Motoranbau rechts

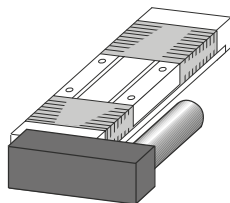

Spindelantrieb mit Motoranbau links

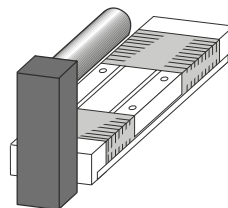

Spindelantrieb mit Motoranbau oben

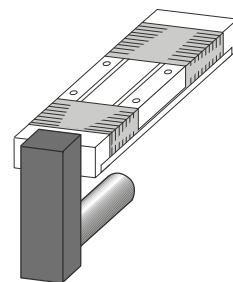

Spindelantrieb mit Motoranbau unten

• ENDSCHALTER-STECKER

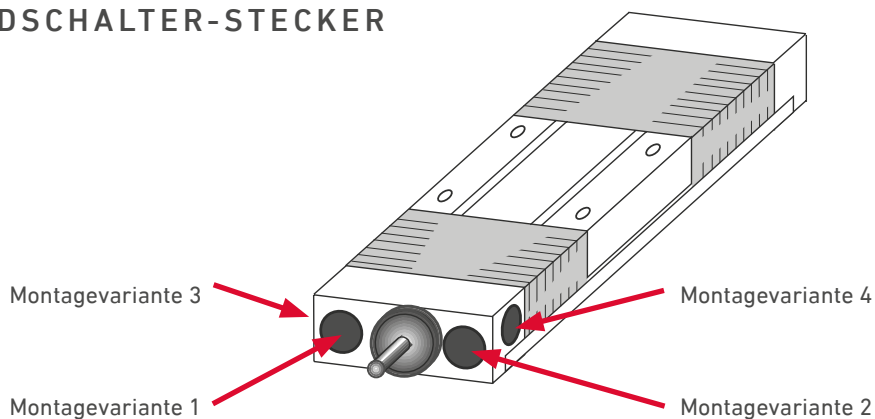

• KREUZTISCHE

Montageart A

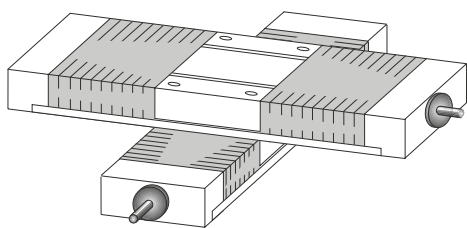

Montageart C

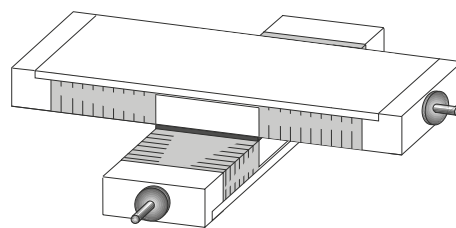

Montageart B

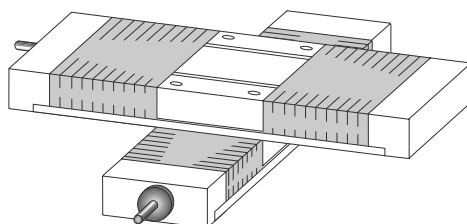

Montageart D

